

1 2 3 4 5 6 7 8

A-A (1:5)

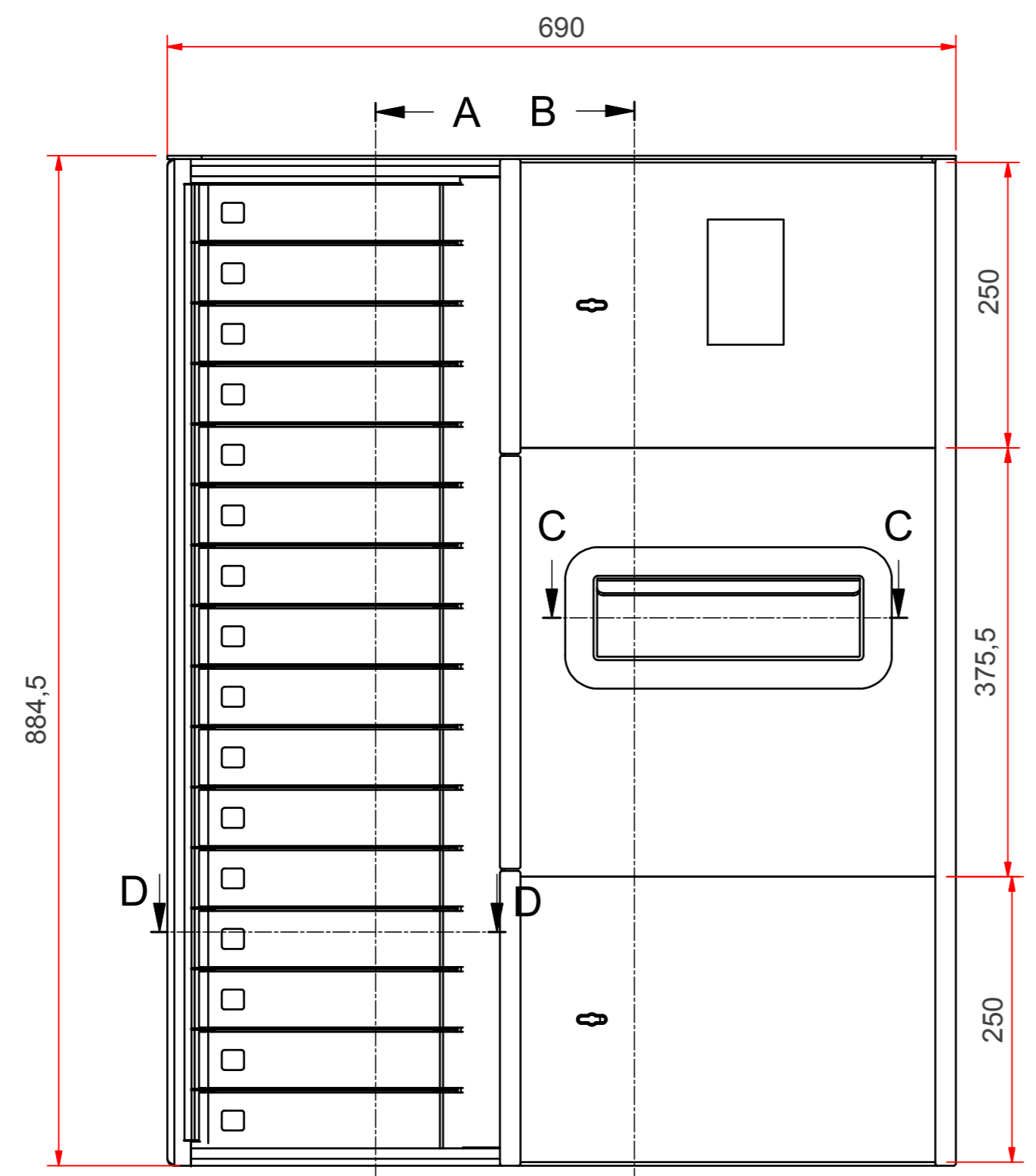

B-B (1:5)

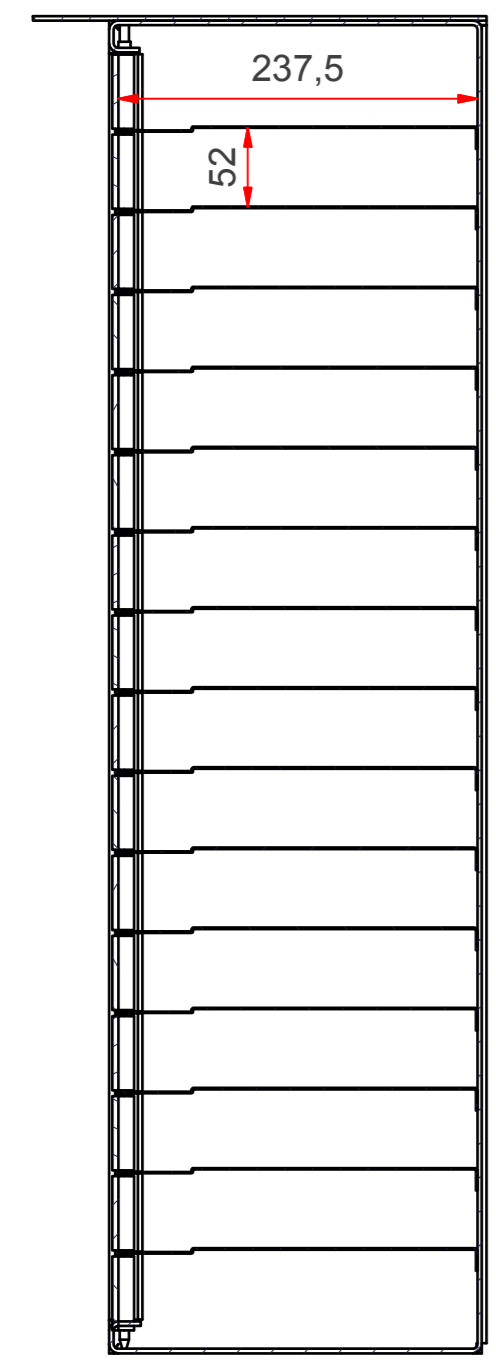
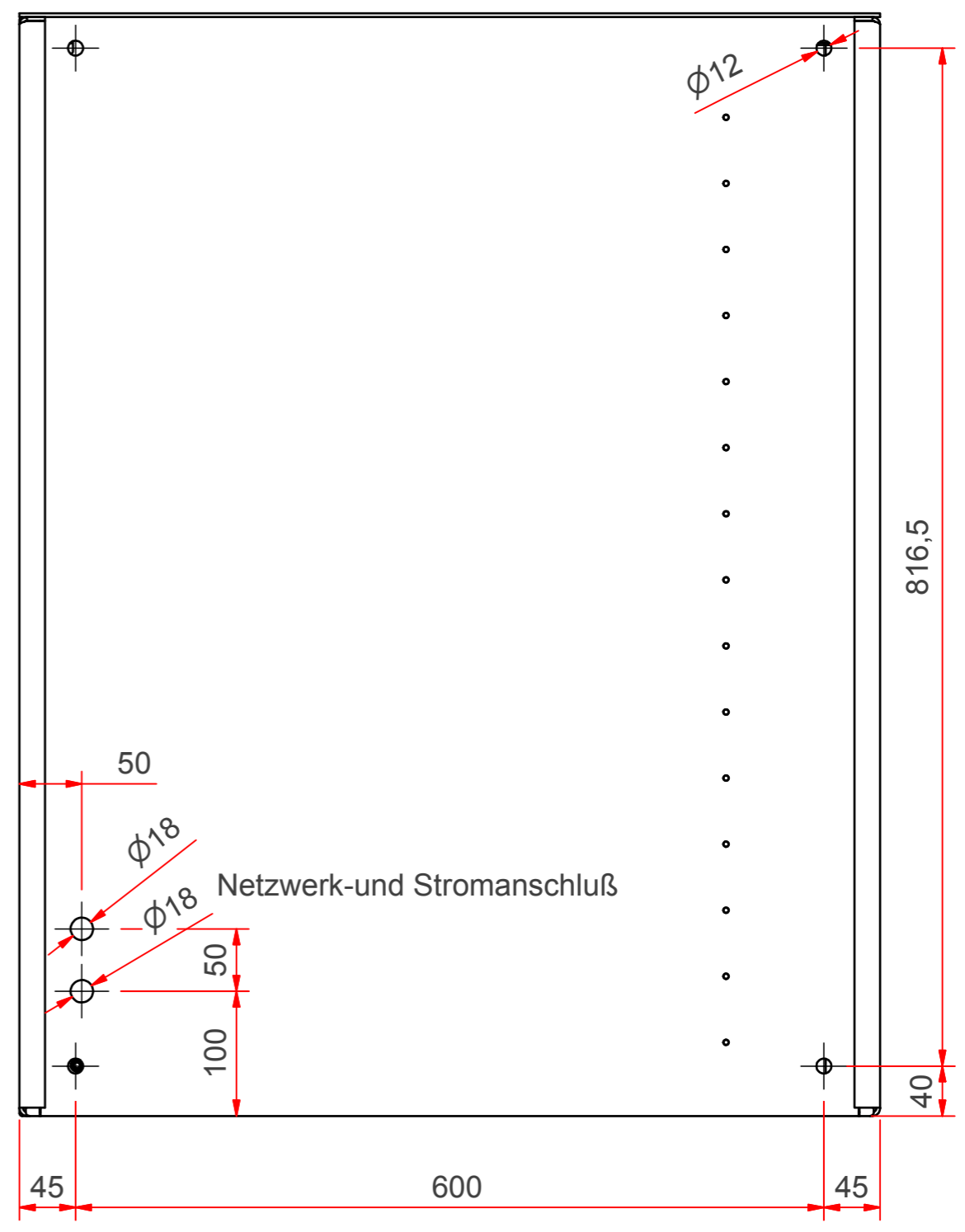
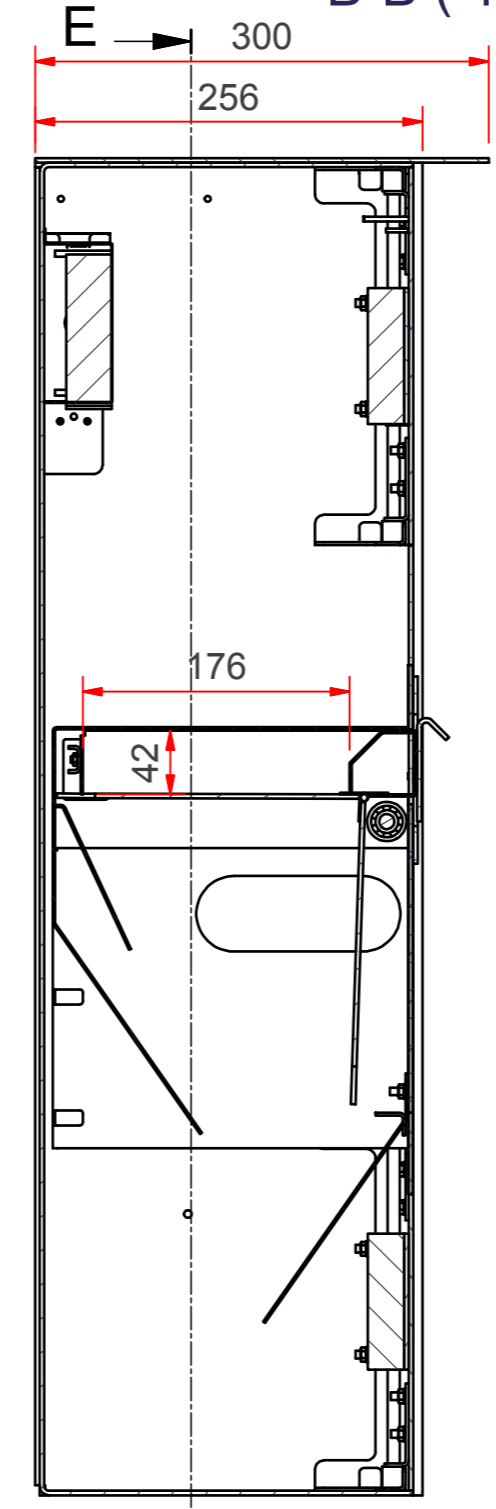

E-E (1:5)

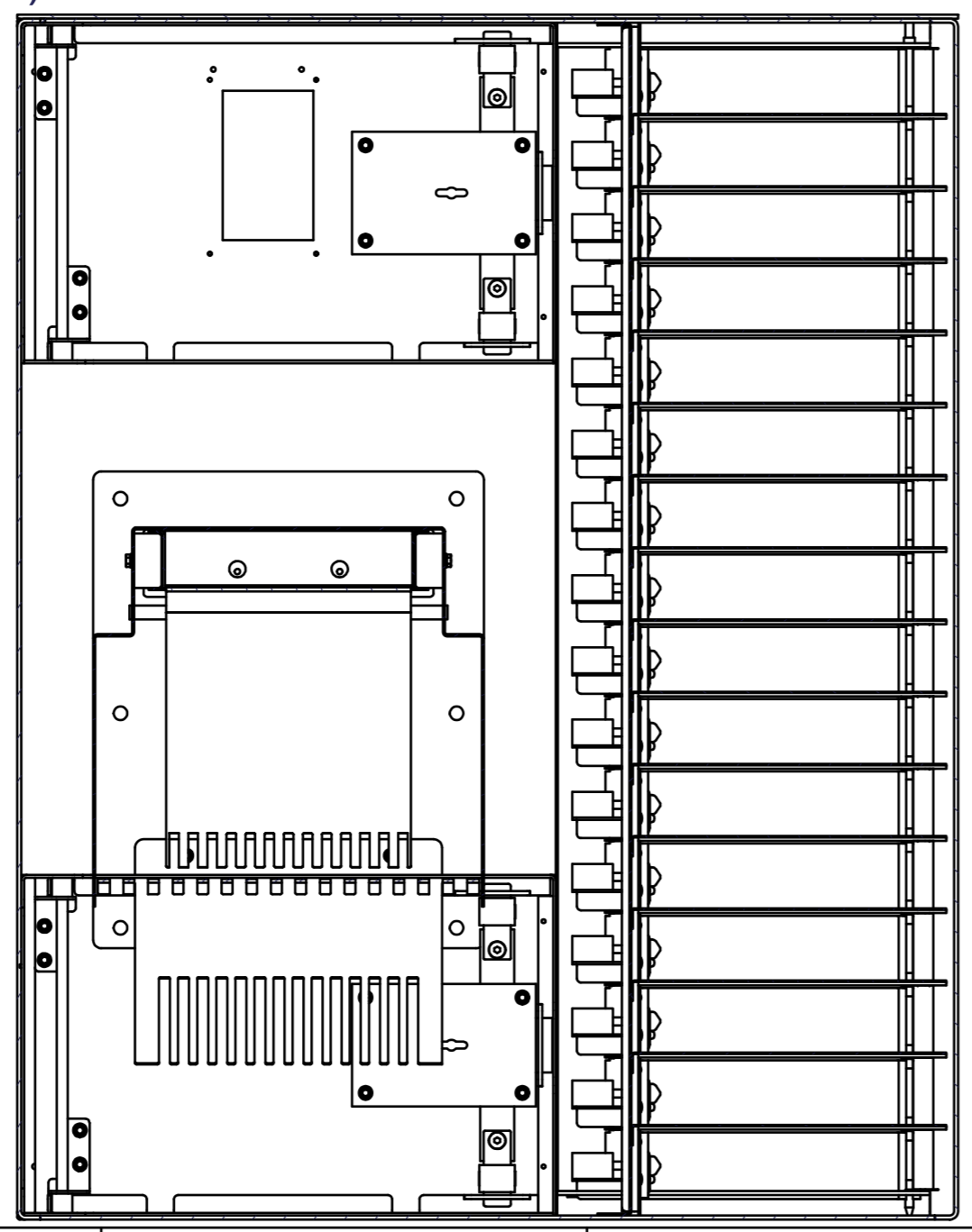

D-D (1:5)

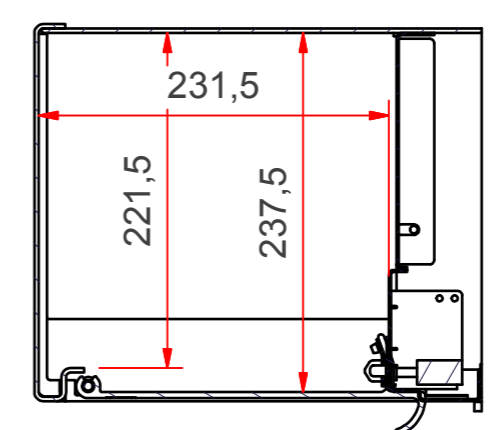

C-C (1:5)

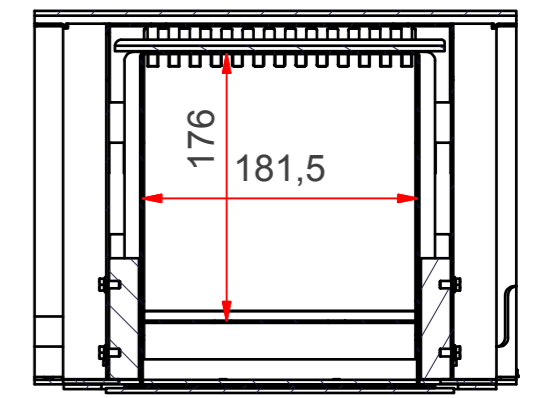

Schutzvermerk nach DIN 34 Für diese Zeichnung behalten wir uns alle Rechte vor, auch für den Fall der Patentierung o. Gebrauchsmustereintragung		Allgemeintoleranzen nach DIN ISO 2768 T1 m und T2 K	DIN 6 	1:5	Revisionsnr.:
		Datum	Name	Bring+Hol 16 Fach	
		Gezeichnet	I-K		
		Kontrolliert			
		Norm		A191105-0000	
Status	Anderungen	Datum	Name	1 A2	